

# RF Coaxial Adapter, 2.40 mm (F) to 2.92 mm (F)

P/N: MLA-240FST-292FST

## Package Contents

Connector	1 Pc
Protection Cap	2 Pcs

## Adapter Configuration

End 1	2.40 mm Female
End 2	2.92 mm Female

## Materials

Description	Material	Finish
Center Pin	Beryllium Copper	Gold-Plated
Shell	Stainless Steel	Passivated

## Electrical Specifications

Impedance	50 Ohms
Frequency Range	DC to 40 GHz
V.S.W.R.	1.20 max. at 40 GHz
Insertion Loss	≤0.38 dB max. at 40 GHz

## Mechanical Specifications

Durability	2.40 mm Female ≥ 1000 Cycles
	2.92 mm Female ≥ 1000 Cycles

## Environmental Specifications

Operating Temperature Range	-55 to +85 °C
-----------------------------	---------------



## Features:

- Designed for Repeatability and Accuracy
- Wide Variety of Mating Interfaces
- Customizable

## Applications:

- High Speed IO Test Setup: Instrumentation Connection to DUT Eval Boards
- Precision Connector Savers
- Adapts Two Different Precision Interfaces



# CAD Drawing

MLA-240FST-292FST

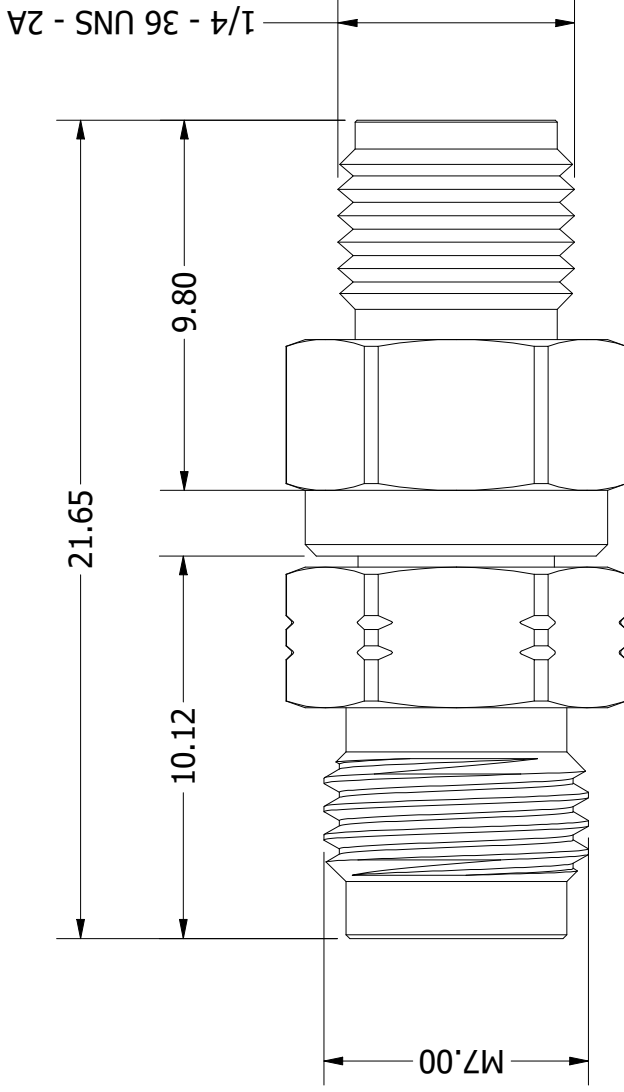

## Title:

RF Coaxial Adapter, 2.40 mm (F) to  
2.92 mm (F)

## Notes:

1. All dimensions are in millimetres unless otherwise specified.
2. These characteristics are typical and for reference.

**multiLane**

[www.multilaneinc.com](http://www.multilaneinc.com)

[sales@multilaneinc.com](mailto:sales@multilaneinc.com)

Rev: A

Scale: 5:1